

# TPS7415, TPS7418, TPS7425, TPS7430, TPS7433 FAST-TRANSIENT-RESPONSE USING SMALL OUTPUT CAPACITOR 200-mA LOW-DROPOUT VOLTAGE REGULATORS

SLVS212 – DECEMBER 1999

- Fast Transient Response Using Small Output Capacitor (10  $\mu$ F)
- 200-mA Low-Dropout Voltage Regulator
- Available in 1.5-V, 1.8-V, 2.5-V, 3-V and 3.3-V
- Dropout Voltage Down to 170 mV at 200 mA (TPS7433)
- 3% Tolerance Over Specified Conditions
- 8-Pin SOIC Package
- Thermal Shutdown Protection

D PACKAGE  
(TOP VIEW)

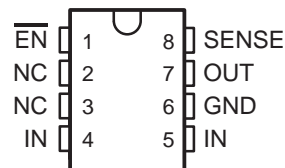

NC – No internal connection

## description

This device is designed to have a fast transient response and be stable with 1- $\mu$ F capacitors. This combination provides high performance at a reasonable cost.

Because the PMOS device behaves as a low-value resistor, the dropout voltage is very low (typically 170 mV at an output current of 200-mA for the TPS7433). This LDO family also features a sleep mode; applying a TTL high signal to  $\overline{\text{EN}}$  (enable) shuts down the regulator, reducing the quiescent current to less than 1  $\mu$ A at  $T_J = 25^\circ\text{C}$ .

The TPS74xx is offered in 1.5-V, 1.8-V, 2.5-V, 3-V, and 3.3-V. Output voltage tolerance is specified as a maximum of 3% over line, load, and temperature ranges. The TPS74xx family is available in 8 pin SOIC package.

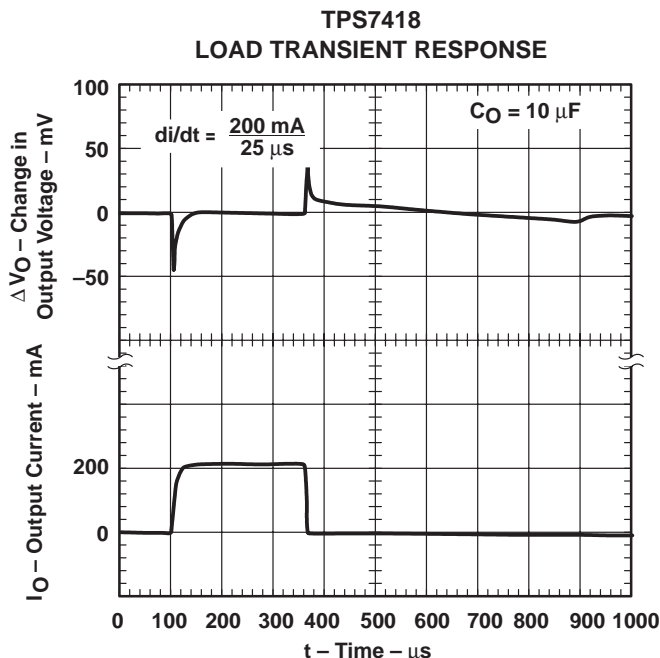
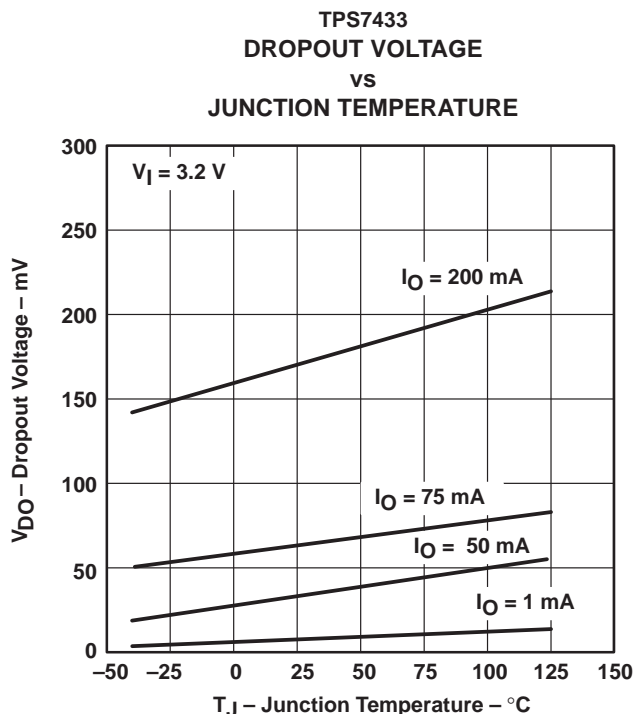

Please be aware that an important notice concerning availability, standard warranty, and use in critical applications of Texas Instruments semiconductor products and disclaimers thereto appears at the end of this data sheet.

PRODUCTION DATA information is current as of publication date. Products conform to specifications per the terms of Texas Instruments standard warranty. Production processing does not necessarily include testing of all parameters.

**TEXAS  
INSTRUMENTS**

POST OFFICE BOX 655303 • DALLAS, TEXAS 75265

Copyright © 1999, Texas Instruments Incorporated

# TPS7415, TPS7418, TPS7425, TPS7430, TPS7433 FAST-TRANSIENT-RESPONSE USING SMALL OUTPUT CAPACITOR 200-mA LOW-DROPOUT VOLTAGE REGULATORS

SLVS212 – DECEMBER 1999

## AVAILABLE OPTIONS

$T_J$	OUTPUT VOLTAGE (V)	PACKAGED DEVICES
	TYP	SOIC (D)
-40°C to 125°C	3.3	TPS7433D
	3	TPS7430D
	2.5	TPS7425D
	1.8	TPS7418D
	1.5	TPS7415D

The D package is available taped and reeled. Add an R suffix to the device type (e.g., TPS7433DR).

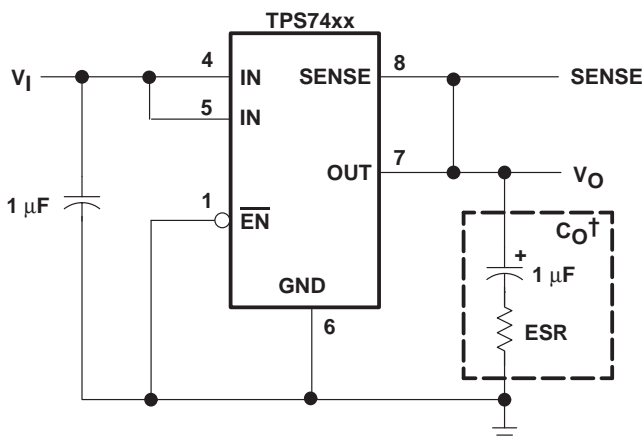

† See application information section for capacitor selection details.

Figure 1. Typical Application Configuration

## functional block diagram

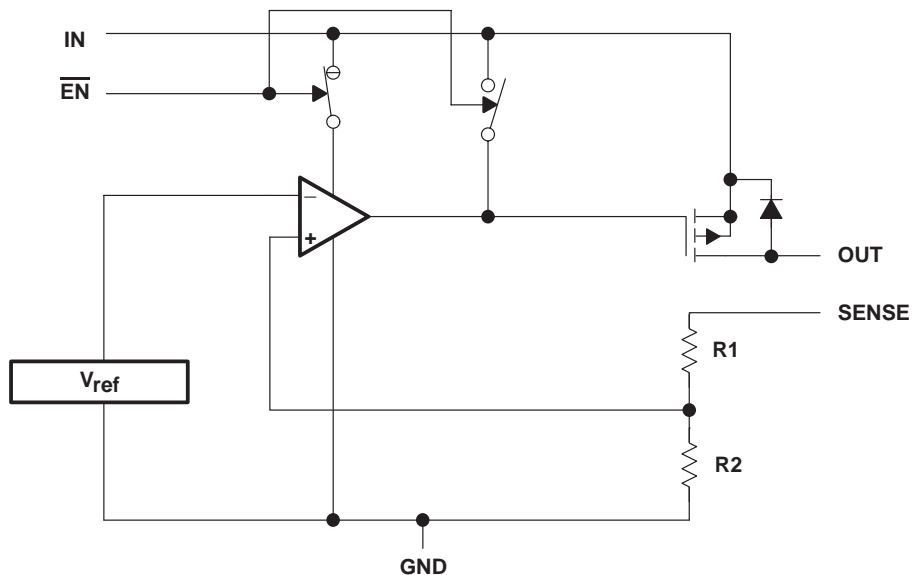

**TPS7415, TPS7418, TPS7425, TPS7430, TPS7433**  
**FAST-TRANSIENT-RESPONSE USING SMALL OUTPUT CAPACITOR**  
**200-mA LOW-DROPOUT VOLTAGE REGULATORS**

SLVS212 – DECEMBER 1999

**Terminal Functions**

TERMINAL NAME	NO.	I/O	DESCRIPTION
$\overline{\text{EN}}$	1	I	Enable input
GND	6		Regulator ground
IN	4, 5	I	Input voltage
NC	2, 3		Not connected
OUT	7	O	Regulated output voltage
SENSE	8	I	Sense

**absolute maximum ratings over operating free-air temperature range (unless otherwise noted)†**

Input voltage range‡, $V_I$	–0.3 V to 8 V
Voltage range at $\overline{\text{EN}}$	–0.3 V to $V_I + 0.3$ V
Peak output current	Internally limited
Continuous total power dissipation	See dissipation rating tables
Operating virtual junction temperature range, $T_J$	–40°C to 125°C
Storage temperature range, $T_{\text{stg}}$	–65°C to 150°C

† Stresses beyond those listed under “absolute maximum ratings” may cause permanent damage to the device. These are stress ratings only, and functional operation of the device at these or any other conditions beyond those indicated under “recommended operating conditions” is not implied. Exposure to absolute-maximum-rated conditions for extended periods may affect device reliability.

‡ All voltage values are with respect to network terminal ground.

**DISSIPATION RATING TABLE 1 – FREE-AIR TEMPERATURES**

PACKAGE	AIR FLOW (CFM)	$T_A < 25^\circ\text{C}$ POWER RATING	DERATING FACTOR ABOVE $T_A = 25^\circ\text{C}$	$T_A = 70^\circ\text{C}$ POWER RATING	$T_A = 85^\circ\text{C}$ POWER RATING
D	0	568 mW	5.68 mW/°C	312 mW	227 mW
	250	904 mW	9.04 mW/°C	497 mW	361 mW

**recommended operating conditions**

	MIN	MAX	UNIT
Input voltage, $V_I$ §	2.5	7	V
Output current, $I_O$ (see Note 1)	0	200	mA
Operating virtual junction temperature, $T_J$ (see Note 1)	–40	125	°C

§ To calculate the minimum input voltage for your maximum output current, use the following equation:  $V_{I(\text{min})} = V_{O(\text{max})} + V_{\text{DO}(\text{max load})}$ .

NOTE 1: Continuous current and operating junction temperature are limited by internal protection circuitry, but it is not recommended that the device operate under conditions beyond those specified in this table for extended periods of time.



**TPS7415, TPS7418, TPS7425, TPS7430, TPS7433**  
**FAST-TRANSIENT-RESPONSE USING SMALL OUTPUT CAPACITOR**  
**200-mA LOW-DROPOUT VOLTAGE REGULATORS**

SLVS212 – DECEMBER 1999

**electrical characteristics over recommended operating free-air temperature range,**  
 **$V_i = V_{O(typ)} + 1\text{ V}$ ,  $I_O = 1\text{ mA}$ ,  $\overline{EN} = 0\text{ V}$ ,  $C_O = 1\text{ }\mu\text{F}$  (unless otherwise noted)**

PARAMETER		TEST CONDITIONS	TEST CONDITIONS	MIN	TYP	MAX	UNIT
Output voltage (10 $\mu\text{A}$ to 200 mA load) (see Note 2)	TPS7415	$2.5\text{ V} < V_I < 7\text{ V}$	$T_J = 25^\circ\text{C}$		1.5		V
			$T_J = -40^\circ\text{C}$ to $125^\circ\text{C}$	1.455	1.545		
	TPS7418	$2.8\text{ V} < V_I < 7\text{ V}$	$T_J = 25^\circ\text{C}$		1.8		
			$T_J = -40^\circ\text{C}$ to $125^\circ\text{C}$	1.746	1.854		
	TPS7425	$3.5\text{ V} < V_I < 7\text{ V}$	$T_J = 25^\circ\text{C}$		2.5		
			$T_J = -40^\circ\text{C}$ to $125^\circ\text{C}$	2.425	2.575		
	TPS7430	$4.0\text{ V} < V_I < 7\text{ V}$	$T_J = 25^\circ\text{C}$		3.0		
			$T_J = -40^\circ\text{C}$ to $125^\circ\text{C}$	2.910	3.090		
	TPS7433	$4.3\text{ V} < V_I < 7\text{ V}$	$T_J = 25^\circ\text{C}$		3.3		
			$T_J = -40^\circ\text{C}$ to $125^\circ\text{C}$	3.201	3.399		
Quiescent current (GND current) (See Note 2)	$I_O = 1\text{ mA}$ , $\overline{EN} = 0\text{ V}$	$T_J = 25^\circ\text{C}$		80		$\mu\text{A}$	
		$T_J = -40^\circ\text{C}$ to $125^\circ\text{C}$		115			
	$I_O = 100\text{ mA}$ , $\overline{EN} = 0\text{ V}$	$T_J = 25^\circ\text{C}$		550		$\mu\text{A}$	
		$T_J = -40^\circ\text{C}$ to $125^\circ\text{C}$		850			
	$I_O = 200\text{ mA}$ , $\overline{EN} = 0\text{ V}$	$T_J = 25^\circ\text{C}$		1300		$\mu\text{A}$	
		$T_J = -40^\circ\text{C}$ to $125^\circ\text{C}$		1500			
Output voltage line regulation ( $\Delta V_O/V_O$ ) (see Notes 2 and 3)	$V_O + 1\text{ V} < V_I \leq 7\text{ V}$ ,	$T_J = 25^\circ\text{C}$		0.06		%/V	
Load regulation				5		mV	
Output noise voltage	$BW = 300\text{ Hz}$ to $50\text{ kHz}$ ,	$C_O = 1\text{ }\mu\text{F}$ ,	$T_J = 25^\circ\text{C}$		190		$\mu\text{V}_{\text{rms}}$
Output current Limit	$V_O = 0\text{ V}$			500	750		mA
Thermal shutdown junction temperature				150			$^\circ\text{C}$
Standby current	$2.5\text{ V} < V_I < 7\text{ V}$ ,	$T_J = 25^\circ\text{C}$	$\overline{EN} = V_I$		1		$\mu\text{A}$
			$\overline{EN} = V_I$		3		
High level enable input voltage				2			V
Low level enable input voltage					0.7		V
Input current (EN)	$\overline{EN} = 0\text{ V}$	$\overline{EN} = V_I$		-1	1		$\mu\text{A}$
				-1	1		
Power supply ripple rejection (see Note 2)	$f = 100\text{ Hz}$ ,	$C_O = 1\text{ }\mu\text{F}$ ,	$T_J = 25^\circ\text{C}$		55		dB
Dropout voltage (see Note 4)	TPS7430	$I_O = 200\text{ mA}$ ,	$T_J = 25^\circ\text{C}$		180		mV
			$T_J = -40^\circ\text{C}$ to $125^\circ\text{C}$		350		
	TPS7433	$I_O = 200\text{ mA}$ ,	$T_J = 25^\circ\text{C}$		170		
			$T_J = -40^\circ\text{C}$ to $125^\circ\text{C}$		315		

- NOTES: 2. Minimum IN operating voltage is  $2.5\text{ V}$  or  $V_{O(typ)} + 1\text{ V}$ , whichever is greater. Maximum IN voltage  $7\text{ V}$ .  
3. If  $V_O = 1.5\text{ V}$  then  $V_{\text{imax}} = 7\text{ V}$ ,  $V_{\text{imin}} = 2.5\text{ V}$ .  
4. IN voltage equals  $V_{O(Typ)} - 100\text{ mV}$ ; TPS7430 and TPS7433 dropout limited by input voltage range limitations (i.e., TPS7430 input voltage needs to drop to  $2.9\text{ V}$  for purpose of this test).

$$\text{Line Reg. (mV)} = (\%/V) \times \frac{V_O(V_{\text{imax}} - 2.5\text{ V})}{100} \times 1000$$

If  $V_O \geq 2.5\text{ V}$  then  $V_{\text{imax}} = 7\text{ V}$ ,  $V_{\text{imin}} = V_O + 1\text{ V}$ :

$$\text{Line Reg. (mV)} = (\%/V) \times \frac{V_O(V_{\text{imax}} - (V_O + 1\text{ V}))}{100} \times 1000$$



TPS7415, TPS7418, TPS7425, TPS7430, TPS7433  
**FAST-TRANSIENT-RESPONSE USING SMALL OUTPUT CAPACITOR**  
**200-mA LOW-DROPOUT VOLTAGE REGULATORS**

SLVS212 – DECEMBER 1999

**Table of Graphs**

			FIGURE
$V_O$	Output voltage	vs Output current	2, 3, 4
		vs Junction temperature	5, 6
	Ground current	vs Junction temperature	7, 8
	Power supply ripple rejection	vs Frequency	12
	Output noise	vs Frequency	9
$Z_o$	Output impedance	vs Frequency	10
$V_{DO}$	Dropout voltage	vs Junction temperature	11
		Line transient response	13, 15
	Load transient response		14, 16
	Output voltage	vs Time	17
	(Stability) Equivalent series resistance (ESR)	vs Output current	19

**TYPICAL CHARACTERISTICS**

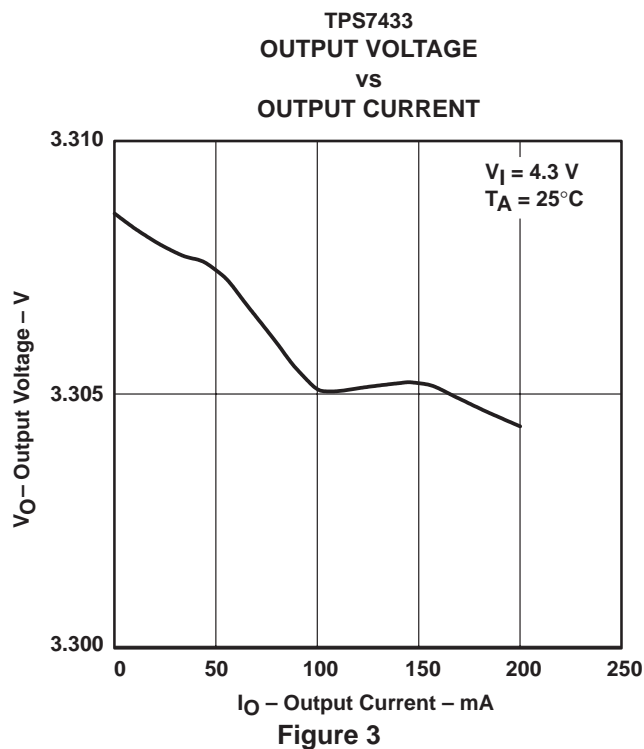
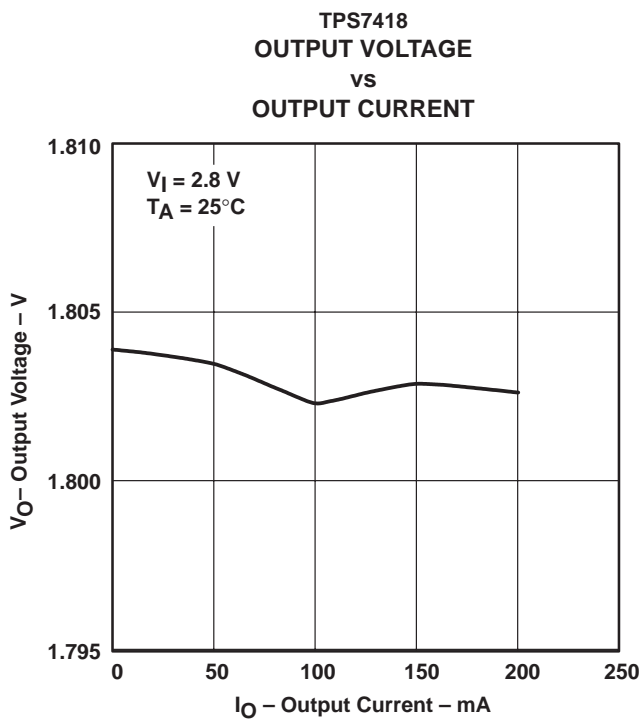

TPS7415, TPS7418, TPS7425, TPS7430, TPS7433  
 FAST-TRANSIENT-RESPONSE USING SMALL OUTPUT CAPACITOR  
 200-mA LOW-DROPOUT VOLTAGE REGULATORS

SLVS212 – DECEMBER 1999

TYPICAL CHARACTERISTICS

TPS7425  
 OUTPUT VOLTAGE  
 vs  
 OUTPUT CURRENT

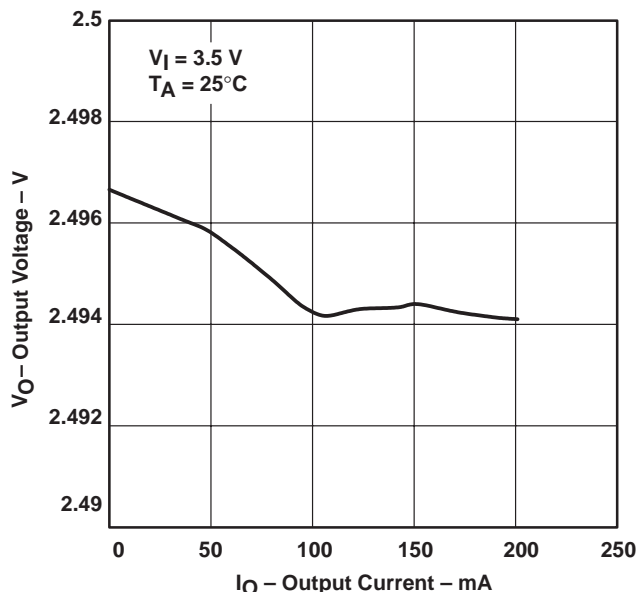

Figure 4

TPS7418  
 OUTPUT VOLTAGE  
 vs  
 JUNCTION TEMPERATURE

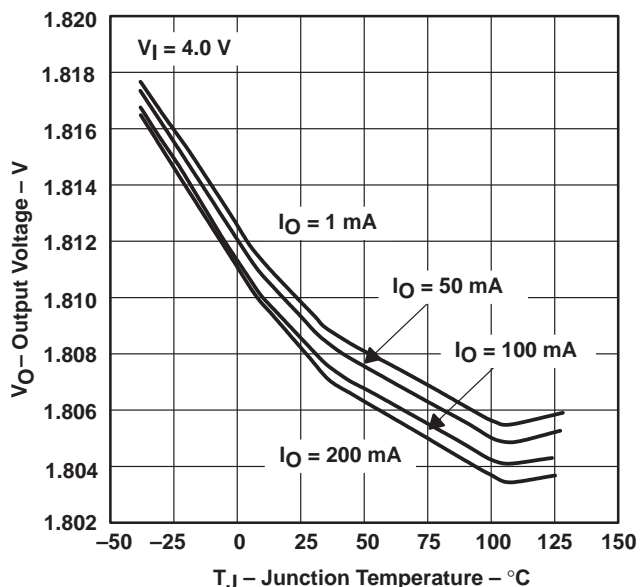

Figure 5

TPS7433  
 OUTPUT VOLTAGE  
 vs  
 JUNCTION TEMPERATURE

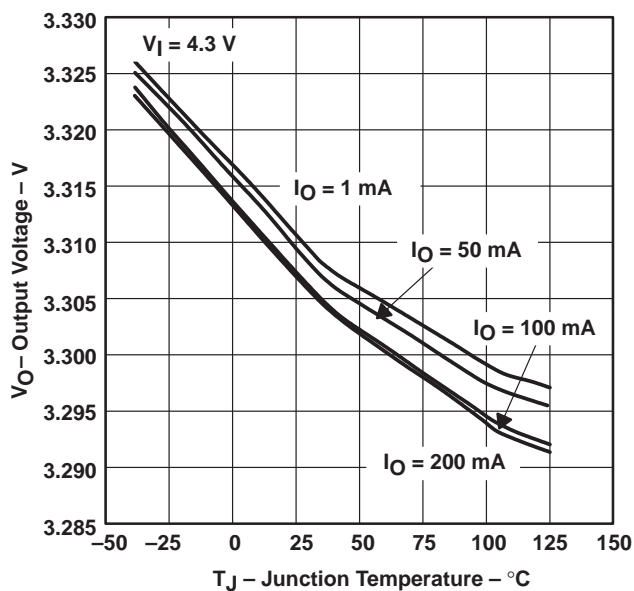

Figure 6

TPS7418  
 GROUND CURRENT  
 vs  
 JUNCTION TEMPERATURE

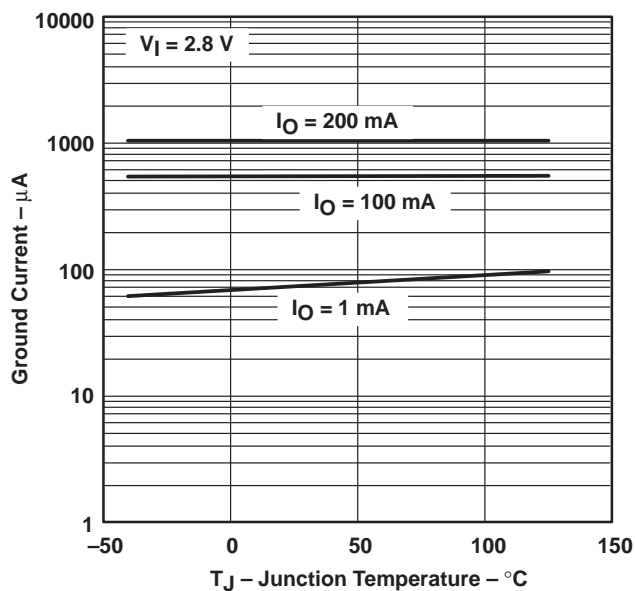

Figure 7



TYPICAL CHARACTERISTICS

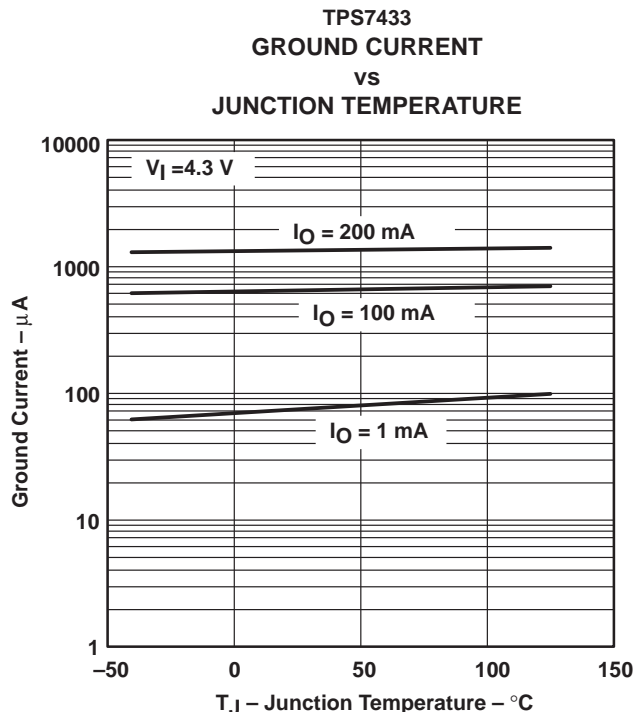

Figure 8

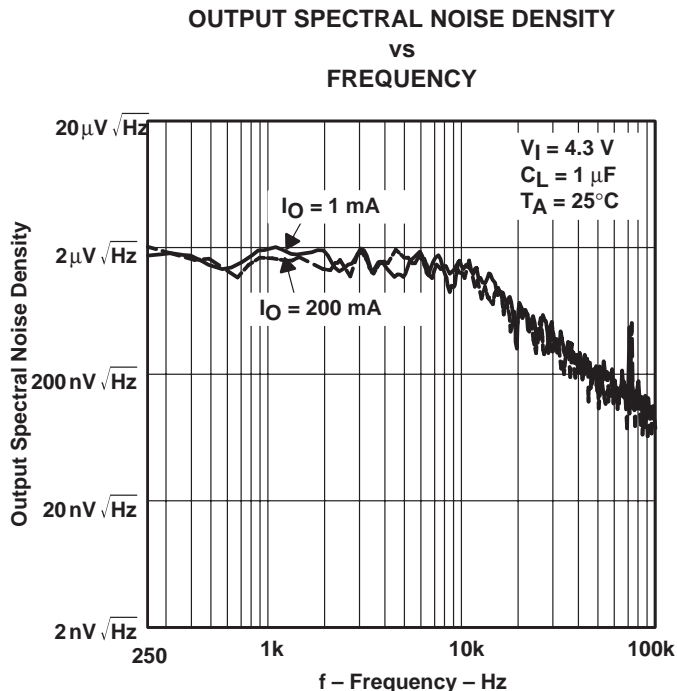

Figure 9

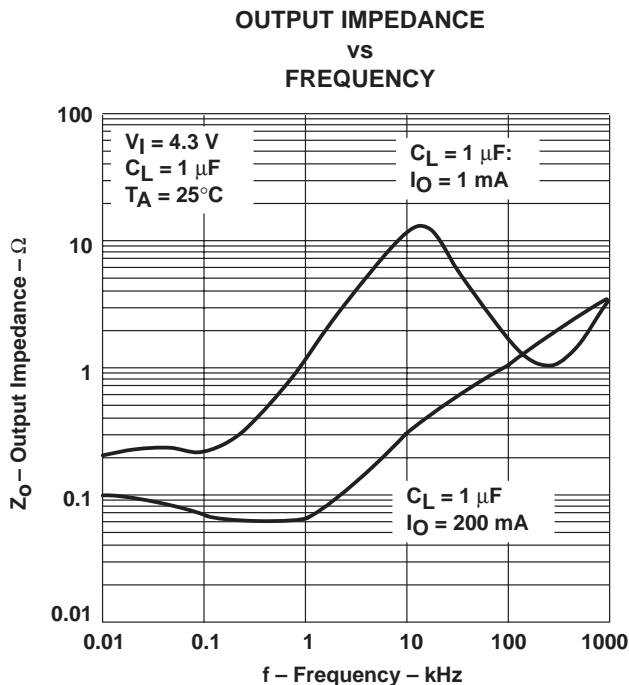

Figure 10

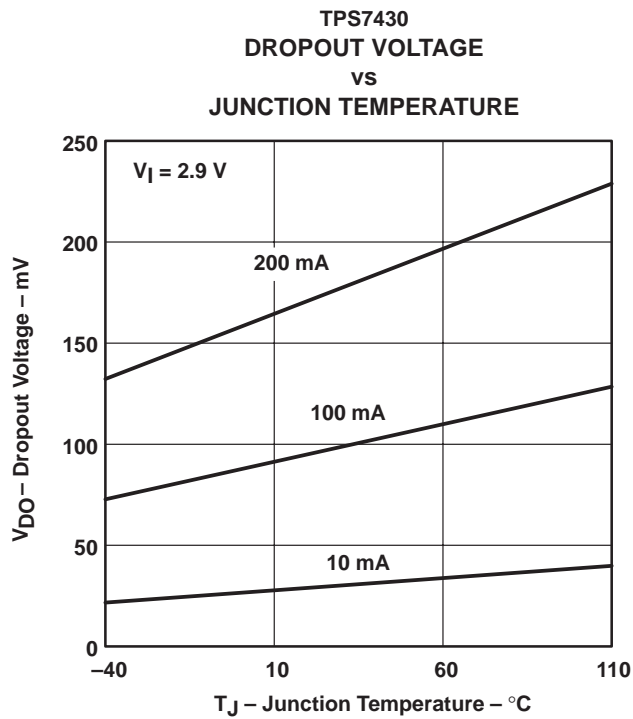

Figure 11

TPS7415, TPS7418, TPS7425, TPS7430, TPS7433  
 FAST-TRANSIENT-RESPONSE USING SMALL OUTPUT CAPACITOR  
 200-mA LOW-DROPOUT VOLTAGE REGULATORS

SLVS212 – DECEMBER 1999

TYPICAL CHARACTERISTICS

RIPPLE REJECTION  
 vs  
 FREQUENCY

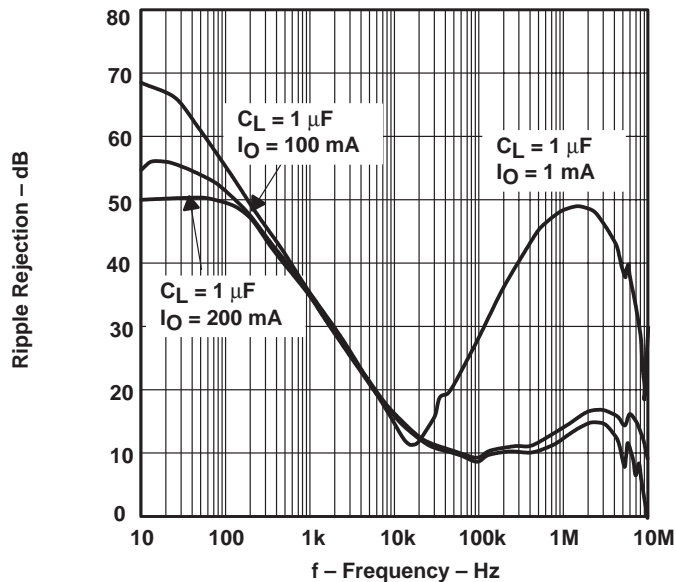

Figure 12

TPS7418  
 LINE TRANSIENT RESPONSE

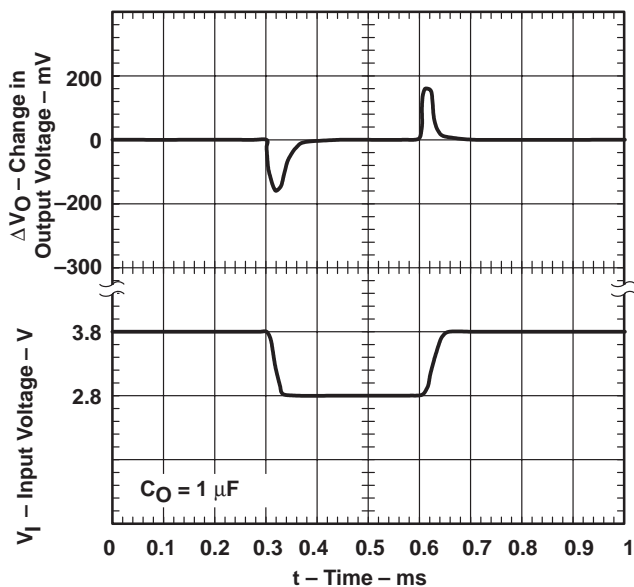

Figure 13

TPS7418  
 LOAD TRANSIENT RESPONSE

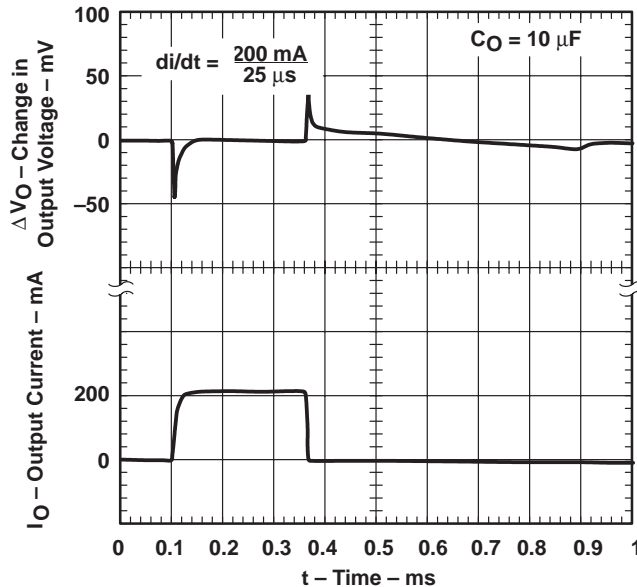

Figure 14



TYPICAL CHARACTERISTICS

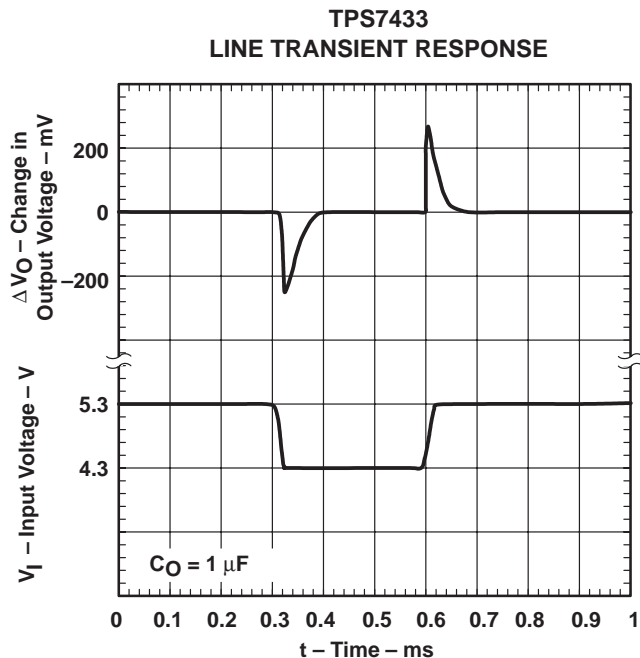

Figure 15

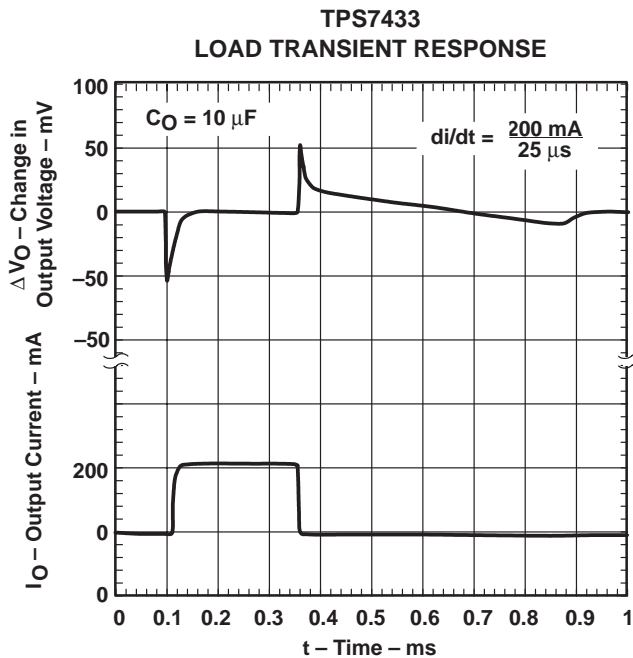

Figure 16

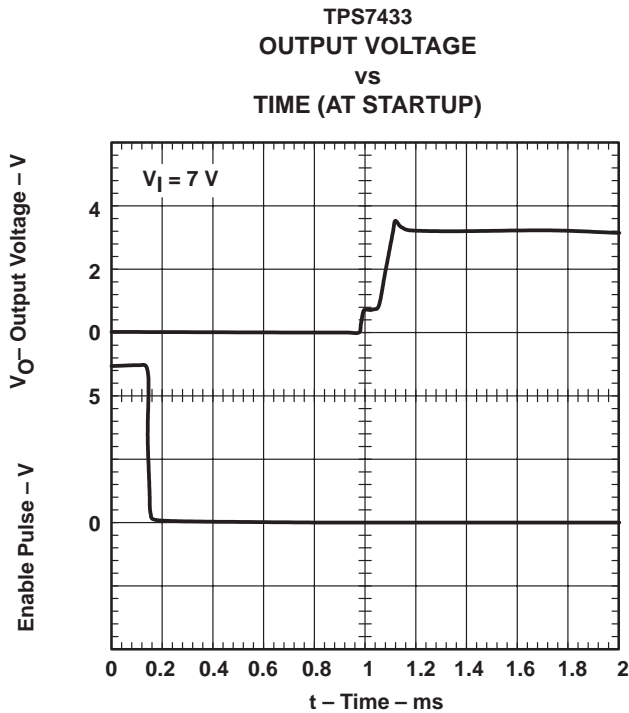

Figure 17

TPS7415, TPS7418, TPS7425, TPS7430, TPS7433  
 FAST-TRANSIENT-RESPONSE USING SMALL OUTPUT CAPACITOR  
 200-mA LOW-DROPOUT VOLTAGE REGULATORS

SLVS212 – DECEMBER 1999

TYPICAL CHARACTERISTICS

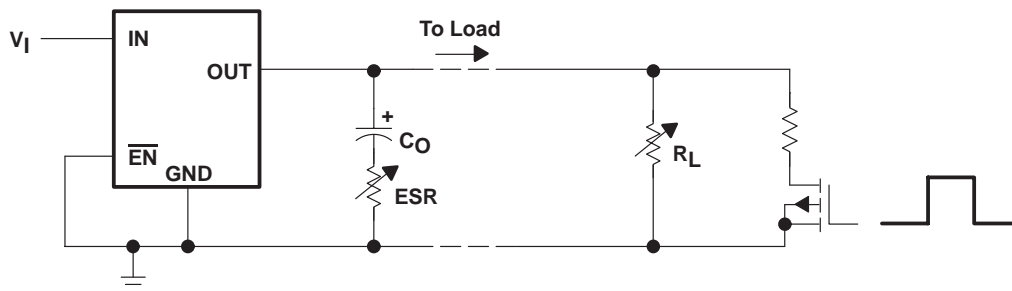

Figure 18. Test Circuit for Typical Regions of Stability (Figure 19)

TYPICAL REGIONS OF STABILITY  
 EQUIVALENT SERIES RESISTANCE (ESR)<sup>†</sup>  
 vs  
 OUTPUT CURRENT

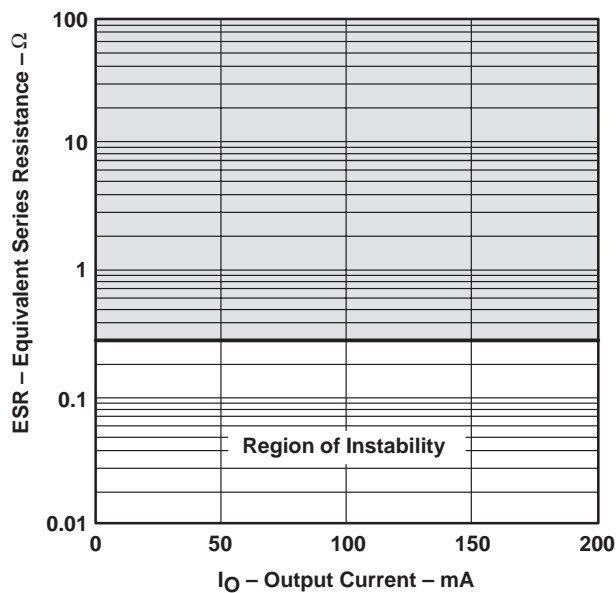

Figure 19

<sup>†</sup> ESR refers to the total series resistance, including the ESR of the capacitor, any series resistance added externally, and PWB trace resistance to C<sub>O</sub>.

## APPLICATION INFORMATION

The TPS74xx family includes five voltage regulators (1.5 V, 1.8 V, 2.5 V, 3 V, and 3.3 V).

### minimum load requirements

The TPS74xx family is stable even at zero load; no minimum load is required for operation.

### SENSE terminal connection

The SENSE terminal must be connected to the regulator output for proper functioning of the regulator. Normally, this connection should be as short as possible; however, the connection can be made near a critical circuit (remote sense) to improve performance at that point. Internally, SENSE connects to a high-impedance wide-bandwidth amplifier through a resistor-divider network and noise pickup feeds through to the regulator output. Routing the SENSE connection to minimize/avoid noise pickup is essential. Adding an RC network between SENSE and OUT to filter noise is not recommended because it can cause the regulator to oscillate.

### external capacitor requirements

An input capacitor is not usually required; however, a ceramic bypass capacitor (1  $\mu\text{F}$  or larger) improves load transient response and noise rejection if the TPS74xx is located more than a few inches from the power supply. A higher-capacitance electrolytic capacitor may be necessary if large (hundreds of milliamps) load transients with fast rise times are anticipated.

Like all low dropout regulators, the TPS74xx requires an output capacitor connected between OUT and GND to stabilize the internal control loop. The minimum recommended capacitance value is 1  $\mu\text{F}$  and the ESR (equivalent series resistance) must be at least 300 m $\Omega$ . Solid tantalum electrolytic and aluminum electrolytic are all suitable, provided they meet the requirements described previously.

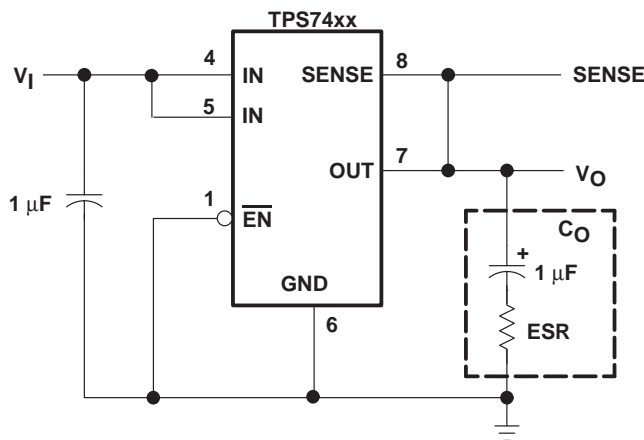

**Figure 20. Typical Application Circuit**

### regulator protection

The TPS74xx PMOS-pass transistor has a built-in back diode that conducts reverse currents when the input voltage drops below the output voltage (e.g., during power down). Current is conducted from the output to the input and is not internally limited. When extended reverse voltage is anticipated, external limiting may be appropriate.

# TPS7415, TPS7418, TPS7425, TPS7430, TPS7433 FAST-TRANSIENT-RESPONSE USING SMALL OUTPUT CAPACITOR 200-mA LOW-DROPOUT VOLTAGE REGULATORS

SLVS212 – DECEMBER 1999

---

## APPLICATION INFORMATION

### regulator protection (continued)

The TPS74xx also features internal current limiting and thermal protection. During normal operation, the TPS74xx limits output current to approximately 500 mA. When current limiting engages, the output voltage scales back linearly until the overcurrent condition ends. While current limiting is designed to prevent gross device failure, care should be taken not to exceed the power dissipation ratings of the package. If the temperature of the device exceeds 150°C(typ), thermal-protection circuitry shuts it down. Once the device has cooled below 130°C (typ), regulator operation resumes.

### power dissipation and junction temperature

Specified regulator operation is assured to a junction temperature of 125°C; the maximum junction temperature should be restricted to 125°C under normal operating conditions. This restriction limits the power dissipation the regulator can handle in any given application. To ensure the junction temperature is within acceptable limits, calculate the maximum allowable dissipation,  $P_{D(max)}$ , and the actual dissipation,  $P_D$ , which must be less than or equal to  $P_{D(max)}$ .

The maximum-power-dissipation limit is determined using the following equation:

$$P_{D(max)} = \frac{T_{Jmax} - T_A}{R_{\theta JA}}$$

Where

$T_{Jmax}$  is the maximum allowable junction temperature.

$R_{\theta JA}$  is the thermal resistance junction-to-ambient for the package, i.e., 172°C/W for the 8-terminal SOIC.

$T_A$  is the ambient temperature.

The regulator dissipation is calculated using:

$$P_D = (V_I - V_O) \times I_O$$

Power dissipation resulting from quiescent current is negligible. Excessive power dissipation will trigger the thermal protection circuit.



POST OFFICE BOX 655303 • DALLAS, TEXAS 75265

TPS7415, TPS7418, TPS7425, TPS7430, TPS7433  
 FAST-TRANSIENT-RESPONSE USING SMALL OUTPUT CAPACITOR  
 200-mA LOW-DROPOUT VOLTAGE REGULATORS

SLVS212 – DECEMBER 1999

MECHANICAL DATA

D (R-PDSO-G\*\*)

PLASTIC SMALL-OUTLINE PACKAGE

14 PIN SHOWN

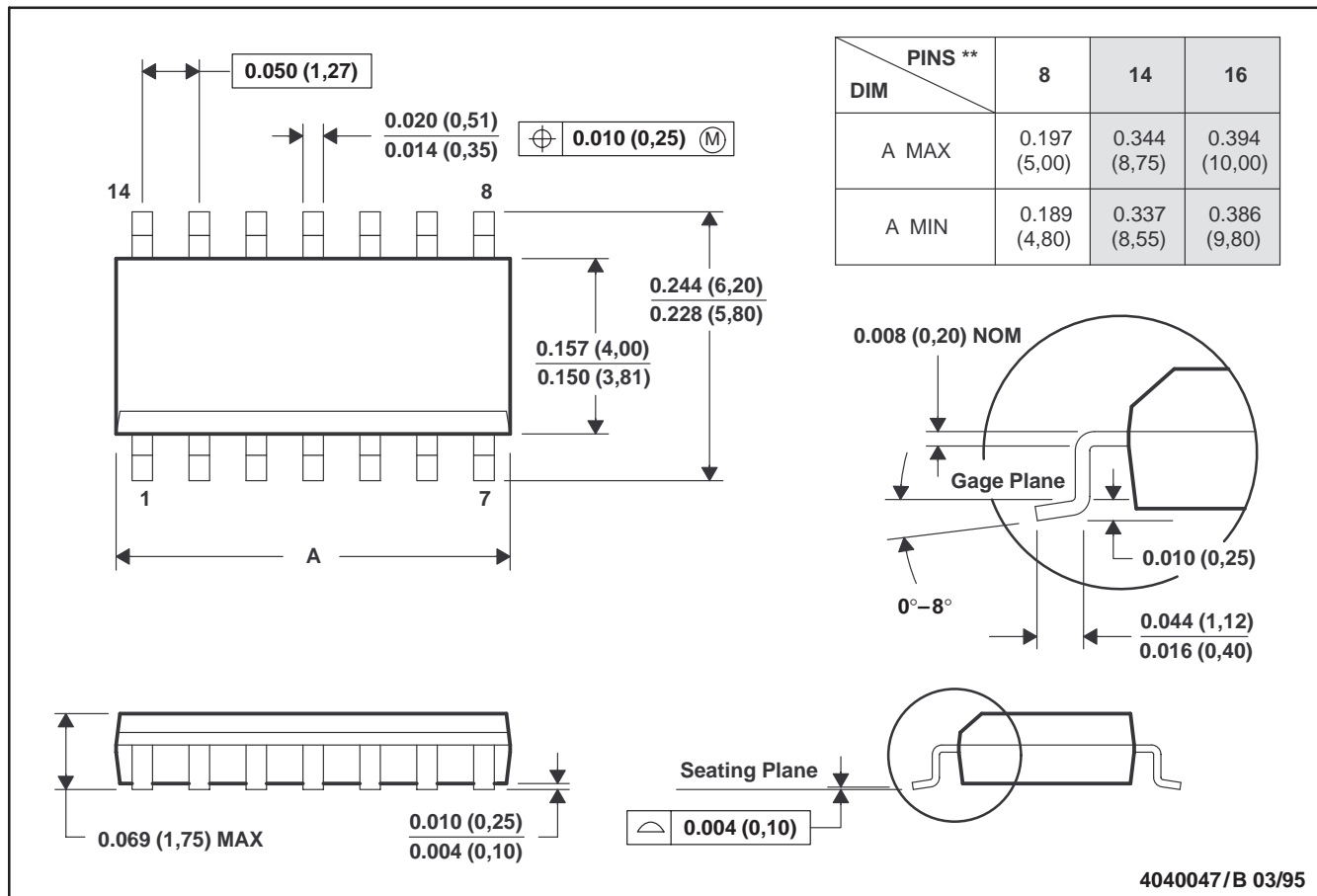

- NOTES: A. All linear dimensions are in inches (millimeters).  
 B. This drawing is subject to change without notice.  
 C. Body dimensions do not include mold flash or protrusion, not to exceed 0.006 (0,15).  
 D. Four center pins are connected to die mount pad.  
 E. Falls within JEDEC MS-012

**PACKAGING INFORMATION**

Orderable Device	Status <sup>(1)</sup>	Package Type	Package Drawing	Pins	Package Qty	Eco Plan <sup>(2)</sup>	Lead/Ball Finish	MSL Peak Temp <sup>(3)</sup>
TPS7415D	ACTIVE	SOIC	D	8	75	Green (RoHS & no Sb/Br)	CU NIPDAU	Level-1-260C-UNLIM
TPS7415DG4	ACTIVE	SOIC	D	8	75	Green (RoHS & no Sb/Br)	CU NIPDAU	Level-1-260C-UNLIM
TPS7415DR	ACTIVE	SOIC	D	8	2500	Green (RoHS & no Sb/Br)	CU NIPDAU	Level-1-260C-UNLIM
TPS7415DRG4	ACTIVE	SOIC	D	8	2500	Green (RoHS & no Sb/Br)	CU NIPDAU	Level-1-260C-UNLIM
TPS7418D	ACTIVE	SOIC	D	8	75	Green (RoHS & no Sb/Br)	CU NIPDAU	Level-1-260C-UNLIM
TPS7418DG4	ACTIVE	SOIC	D	8	75	Green (RoHS & no Sb/Br)	CU NIPDAU	Level-1-260C-UNLIM
TPS7425D	ACTIVE	SOIC	D	8	75	Green (RoHS & no Sb/Br)	CU NIPDAU	Level-1-260C-UNLIM
TPS7425DG4	ACTIVE	SOIC	D	8	75	Green (RoHS & no Sb/Br)	CU NIPDAU	Level-1-260C-UNLIM
TPS7425DR	ACTIVE	SOIC	D	8	2500	Green (RoHS & no Sb/Br)	CU NIPDAU	Level-1-260C-UNLIM
TPS7425DRG4	ACTIVE	SOIC	D	8	2500	Green (RoHS & no Sb/Br)	CU NIPDAU	Level-1-260C-UNLIM
TPS7430D	ACTIVE	SOIC	D	8	75	Green (RoHS & no Sb/Br)	CU NIPDAU	Level-1-260C-UNLIM
TPS7430DG4	ACTIVE	SOIC	D	8	75	Green (RoHS & no Sb/Br)	CU NIPDAU	Level-1-260C-UNLIM
TPS7433D	ACTIVE	SOIC	D	8	75	Green (RoHS & no Sb/Br)	CU NIPDAU	Level-1-260C-UNLIM
TPS7433DG4	ACTIVE	SOIC	D	8	75	Green (RoHS & no Sb/Br)	CU NIPDAU	Level-1-260C-UNLIM
TPS7433DR	ACTIVE	SOIC	D	8	2500	Green (RoHS & no Sb/Br)	CU NIPDAU	Level-1-260C-UNLIM
TPS7433DRG4	ACTIVE	SOIC	D	8	2500	Green (RoHS & no Sb/Br)	CU NIPDAU	Level-1-260C-UNLIM

<sup>(1)</sup> The marketing status values are defined as follows:

**ACTIVE:** Product device recommended for new designs.

**LIFEBUY:** TI has announced that the device will be discontinued, and a lifetime-buy period is in effect.

**NRND:** Not recommended for new designs. Device is in production to support existing customers, but TI does not recommend using this part in a new design.

**PREVIEW:** Device has been announced but is not in production. Samples may or may not be available.

**OBSOLETE:** TI has discontinued the production of the device.

<sup>(2)</sup> Eco Plan - The planned eco-friendly classification: Pb-Free (RoHS), Pb-Free (RoHS Exempt), or Green (RoHS & no Sb/Br) - please check <http://www.ti.com/productcontent> for the latest availability information and additional product content details.

**TBD:** The Pb-Free/Green conversion plan has not been defined.

**Pb-Free (RoHS):** TI's terms "Lead-Free" or "Pb-Free" mean semiconductor products that are compatible with the current RoHS requirements for all 6 substances, including the requirement that lead not exceed 0.1% by weight in homogeneous materials. Where designed to be soldered at high temperatures, TI Pb-Free products are suitable for use in specified lead-free processes.

**Pb-Free (RoHS Exempt):** This component has a RoHS exemption for either 1) lead-based flip-chip solder bumps used between the die and package, or 2) lead-based die adhesive used between the die and leadframe. The component is otherwise considered Pb-Free (RoHS compatible) as defined above.

**Green (RoHS & no Sb/Br):** TI defines "Green" to mean Pb-Free (RoHS compatible), and free of Bromine (Br) and Antimony (Sb) based flame retardants (Br or Sb do not exceed 0.1% by weight in homogeneous material)

<sup>(3)</sup> MSL, Peak Temp. -- The Moisture Sensitivity Level rating according to the JEDEC industry standard classifications, and peak solder temperature.

**Important Information and Disclaimer:**The information provided on this page represents TI's knowledge and belief as of the date that it is provided. TI bases its knowledge and belief on information provided by third parties, and makes no representation or warranty as to the accuracy of such information. Efforts are underway to better integrate information from third parties. TI has taken and continues to take reasonable steps to provide representative and accurate information but may not have conducted destructive testing or chemical analysis on incoming materials and chemicals. TI and TI suppliers consider certain information to be proprietary, and thus CAS numbers and other limited information may not be available for release.

In no event shall TI's liability arising out of such information exceed the total purchase price of the TI part(s) at issue in this document sold by TI to Customer on an annual basis.

**TAPE AND REEL INFORMATION**



**QUADRANT ASSIGNMENTS FOR PIN 1 ORIENTATION IN TAPE**



\*All dimensions are nominal

Device	Package Type	Package Drawing	Pins	SPQ	Reel Diameter (mm)	Reel Width W1 (mm)	A0 (mm)	B0 (mm)	K0 (mm)	P1 (mm)	W (mm)	Pin1 Quadrant
TPS7415DR	SOIC	D	8	2500	330.0	12.4	6.4	5.2	2.1	8.0	12.0	Q1
TPS7425DR	SOIC	D	8	2500	330.0	12.4	6.4	5.2	2.1	8.0	12.0	Q1
TPS7433DR	SOIC	D	8	2500	330.0	12.4	6.4	5.2	2.1	8.0	12.0	Q1



**TAPE AND REEL BOX DIMENSIONS**



\*All dimensions are nominal

Device	Package Type	Package Drawing	Pins	SPQ	Length (mm)	Width (mm)	Height (mm)
TPS7415DR	SOIC	D	8	2500	346.0	346.0	29.0
TPS7425DR	SOIC	D	8	2500	346.0	346.0	29.0
TPS7433DR	SOIC	D	8	2500	346.0	346.0	29.0

## IMPORTANT NOTICE

Texas Instruments Incorporated and its subsidiaries (TI) reserve the right to make corrections, modifications, enhancements, improvements, and other changes to its products and services at any time and to discontinue any product or service without notice. Customers should obtain the latest relevant information before placing orders and should verify that such information is current and complete. All products are sold subject to TI's terms and conditions of sale supplied at the time of order acknowledgment.

TI warrants performance of its hardware products to the specifications applicable at the time of sale in accordance with TI's standard warranty. Testing and other quality control techniques are used to the extent TI deems necessary to support this warranty. Except where mandated by government requirements, testing of all parameters of each product is not necessarily performed.

TI assumes no liability for applications assistance or customer product design. Customers are responsible for their products and applications using TI components. To minimize the risks associated with customer products and applications, customers should provide adequate design and operating safeguards.

TI does not warrant or represent that any license, either express or implied, is granted under any TI patent right, copyright, mask work right, or other TI intellectual property right relating to any combination, machine, or process in which TI products or services are used. Information published by TI regarding third-party products or services does not constitute a license from TI to use such products or services or a warranty or endorsement thereof. Use of such information may require a license from a third party under the patents or other intellectual property of the third party, or a license from TI under the patents or other intellectual property of TI.

Reproduction of TI information in TI data books or data sheets is permissible only if reproduction is without alteration and is accompanied by all associated warranties, conditions, limitations, and notices. Reproduction of this information with alteration is an unfair and deceptive business practice. TI is not responsible or liable for such altered documentation. Information of third parties may be subject to additional restrictions.

Resale of TI products or services with statements different from or beyond the parameters stated by TI for that product or service voids all express and any implied warranties for the associated TI product or service and is an unfair and deceptive business practice. TI is not responsible or liable for any such statements.

TI products are not authorized for use in safety-critical applications (such as life support) where a failure of the TI product would reasonably be expected to cause severe personal injury or death, unless officers of the parties have executed an agreement specifically governing such use. Buyers represent that they have all necessary expertise in the safety and regulatory ramifications of their applications, and acknowledge and agree that they are solely responsible for all legal, regulatory and safety-related requirements concerning their products and any use of TI products in such safety-critical applications, notwithstanding any applications-related information or support that may be provided by TI. Further, Buyers must fully indemnify TI and its representatives against any damages arising out of the use of TI products in such safety-critical applications.

TI products are neither designed nor intended for use in military/aerospace applications or environments unless the TI products are specifically designated by TI as military-grade or "enhanced plastic." Only products designated by TI as military-grade meet military specifications. Buyers acknowledge and agree that any such use of TI products which TI has not designated as military-grade is solely at the Buyer's risk, and that they are solely responsible for compliance with all legal and regulatory requirements in connection with such use.

TI products are neither designed nor intended for use in automotive applications or environments unless the specific TI products are designated by TI as compliant with ISO/TS 16949 requirements. Buyers acknowledge and agree that, if they use any non-designated products in automotive applications, TI will not be responsible for any failure to meet such requirements.

Following are URLs where you can obtain information on other Texas Instruments products and application solutions:

### Products

Amplifiers	<a href="http://amplifier.ti.com">amplifier.ti.com</a>
Data Converters	<a href="http://dataconverter.ti.com">dataconverter.ti.com</a>
DSP	<a href="http://dsp.ti.com">dsp.ti.com</a>
Clocks and Timers	<a href="http://www.ti.com/clocks">www.ti.com/clocks</a>
Interface	<a href="http://interface.ti.com">interface.ti.com</a>
Logic	<a href="http://logic.ti.com">logic.ti.com</a>
Power Mgmt	<a href="http://power.ti.com">power.ti.com</a>
Microcontrollers	<a href="http://microcontroller.ti.com">microcontroller.ti.com</a>
RFID	<a href="http://www.ti-rfid.com">www.ti-rfid.com</a>
RF/IF and ZigBee® Solutions	<a href="http://www.ti.com/lprf">www.ti.com/lprf</a>

### Applications

Audio	<a href="http://www.ti.com/audio">www.ti.com/audio</a>
Automotive	<a href="http://www.ti.com/automotive">www.ti.com/automotive</a>
Broadband	<a href="http://www.ti.com/broadband">www.ti.com/broadband</a>
Digital Control	<a href="http://www.ti.com/digitalcontrol">www.ti.com/digitalcontrol</a>
Medical	<a href="http://www.ti.com/medical">www.ti.com/medical</a>
Military	<a href="http://www.ti.com/military">www.ti.com/military</a>
Optical Networking	<a href="http://www.ti.com/opticalnetwork">www.ti.com/opticalnetwork</a>
Security	<a href="http://www.ti.com/security">www.ti.com/security</a>
Telephony	<a href="http://www.ti.com/telephony">www.ti.com/telephony</a>
Video & Imaging	<a href="http://www.ti.com/video">www.ti.com/video</a>
Wireless	<a href="http://www.ti.com/wireless">www.ti.com/wireless</a>

Mailing Address: Texas Instruments, Post Office Box 655303, Dallas, Texas 75265  
Copyright © 2008, Texas Instruments Incorporated